

MAX1300A Evaluation Kit

Evaluates: MAX1300A/MAX1300B

General Description

The MAX1300A evaluation kit (EV kit) is a fully assembled and tested PCB that evaluates the MAX1300A family of 16-bit ADCs. The EV kit uses Windows XP®, Windows Vista®, and Windows® 7-compatible software to provide a simple graphical user interface (GUI) to simplify evaluation of the IC's features. The EV kit comes with the MAX1300AEUG+ installed.

The EV kit has an on-board Xilinx FPGA for evaluating the IC. The EV kit GUI allows different sample sizes, adjustable sampling rates, internal or external reference options, and graphing software that includes the FFT of the sampled signals.

Contact the factory for free samples of the pin-compatible MAX1300BEUG+ to evaluate this device.

[Ordering Information](#) appears at end of data sheet.

Features

- ◆ Windows XP-, Windows Vista-, and Windows 7-Compatible Software
- ◆ On-Board Transformers for Power-Supply Isolation
- ◆ Various Sample Sizes and Sample Rates
- ◆ Time Domain, Frequency Domain, and Histogram Plotting
- ◆ Frequency, RMS, Min, Max, and Average DC Calculations
- ◆ Collects Up to One Million Samples
- ◆ Eight Analog Input Channels
- ◆ +4.096V On-Board Reference
- ◆ Proven PCB Layout
- ◆ Fully Assembled and Tested

Component List

| DESIGNATION | QTY | DESCRIPTION |
|---|-----|--|
| C1–C4, C16, C17, C20–C24, C27, C28, C31, C37, C100, C101, C104–C108, C111, C112, C125, C127, C143, C144, C145, C171, C173, C174 | 32 | 0.1µF ±10%, 16V X7R ceramic capacitors (0603) TDK C1608X7R1C104K |
| C5, C6, C15 | 3 | 220pF ±5%, 50V C0G ceramic capacitors (0805) Murata GRM2165C1H221J |
| C7–C13 | 7 | 0.1µF ±10%, 16V X7R ceramic capacitors (0805) Murata GRM219R71C104K |
| C18, C19, C102, C117, C119, C123, C124, C126, C128 | 9 | 10µF ±10%, 25V X5R ceramic capacitors (1206) Murata GRM31CR61E106K |
| C25, C26, C116, C118, C122, C175 | 6 | 4.7µF ±10%, 25V X5R ceramic capacitors (1206) Murata GRM31CR71E475M |

| DESIGNATION | QTY | DESCRIPTION |
|--|-----|---|
| C29 | 1 | 0.1µF ±5%, 50V C0G ceramic capacitor (1206) Murata GRM31C5C14104J |
| C103, C170 | 2 | 1µF ±10%, 16V X5R ceramic capacitors (0603) Murata GRM188R61C105K |
| C109, C110, C142 | 3 | 10pF ±5%, 50V C0G ceramic capacitors (0603) Murata GRM1885C1H100J |
| C113, C114 | 2 | 22pF ±5%, 50V C0G ceramic capacitors (0603) Murata GRM1885C1H220J |
| C115 | 1 | 0.033µF ±10%, 16V X7R ceramic capacitor (0603) Murata GRM188R71C333K |
| C120, C121 | 2 | 47µF ±20%, 6.3V capacitors (B1) SANYO 6TPC47MB |
| C129, C131, C133, C135, C139, C146, C148, C150, C152, C154, C156, C158, C160, C162, C164, C166, C168 | 17 | 47nF ±10%, 16V X7R ceramic capacitors (0603) Murata GRM188R71C473K |

Windows, Windows XP, and Windows Vista are registered trademarks of Microsoft Corp.

MAX1300A Evaluation Kit

Evaluates: MAX1300A/MAX1300B

Component List (continued)

| DESIGNATION | QTY | DESCRIPTION |
|--|-----|--|
| C130, C132, C134, C136, C147, C149, C151, C153, C155, C157, C159, C161, C163, C165, C167, C169 | 16 | 1nF \pm 10%, 50V X7R ceramic capacitors (0603) Murata GRM188R71H102K |
| C137, C138 | 2 | 39pF \pm 5%, 50V C0G ceramic capacitors (0603) Murata GRM1885C1H390J |
| C140, C172 | 2 | 0.01 μ F \pm 10%, 50V X7R ceramic capacitors (0603) Murata GRM188R71H103K |
| C141 | 1 | 15pF \pm 5%, 50V C0G ceramic capacitor (0603) Murata GRM1885C1H150J |
| D1, D2 | 2 | 50V, 1A general-purpose diodes (SMA) |
| D3 | 1 | Green LED (0603) |
| D4 | 1 | 15V zener diode (DO35) Diodes Inc 1N5245B-T |
| D5–D8 | 4 | 30V, 1A Schottky diodes (SOD123) Diodes Inc. B130LAW |
| J100 | 0 | Not installed, dual-row 24-pin (2 x 12) header |
| J101 | 1 | 20-pin (2 x 10) header |
| JSPI | 0 | Not installed, 6-pin header |
| JTAG1 | 1 | 6-pin header |
| JTAG2 | 1 | 10-pin (2 x 5) header |
| JU1–JU8, JU10, JU11, JU12 | 11 | 3-pin headers |
| JU9, JU101–JU104 | 5 | 2-pin headers |
| JU105 | 0 | Not installed, 3-pin header |
| JU107–JU110 | 0 | Not installed, 2-pin headers |
| L100 | 1 | Ferrite bead (0603) TDK MMZ1608R301A |
| L101 | 1 | 22 μ H, 0.11 Ω , 300mA inductor Coilcraft DS1608C-223ML |
| LED1, LED2, LED3 | 3 | Red LEDs (0603) Panasonic LNJ208R8ARA |
| P100 | 1 | USB type-B right-angle PC-mount receptacle |
| PGND, VIN | 2 | Uninsulated banana panel jacks |

| DESIGNATION | QTY | DESCRIPTION |
|--|-----|--|
| Q100 | 0 | Not installed, p-channel FET (SOT223) Fairchild NDT456P |
| R1, R2 | 2 | 100 Ω \pm 1% resistors (0603) |
| R3–R8 | 6 | 21 Ω \pm 1% resistors (0603) |
| R9 | 1 | 0 Ω \pm 5% resistor |
| R10–R13, R101–R105 | 0 | Not installed, resistors (0603) R10–R13 are open; R101–R105 are short (PC trace) |
| R14, R151 | 2 | 390 Ω \pm 5% resistors (0603) |
| R15–R19, R154, R157 | 7 | 330 Ω \pm 5% resistors (0603) |
| R20, R21, R22 | 3 | 51 Ω \pm 5% resistors (0603) |
| R100, R133 | 2 | 1k Ω \pm 5% resistors (0603) |
| R106, R128, R129, R130, R132 | 5 | 10k Ω \pm 5% resistors (0603) |
| R107 | 1 | 2.2k Ω \pm 5% resistor (0603) |
| R108 | 1 | 1.5k Ω \pm 5% resistor (0603) |
| R109, R110 | 2 | 27 Ω \pm 5% resistors (0603) |
| R111, R114, R120 | 3 | 100k Ω \pm 5% resistors (0603) |
| R112 | 1 | 18.7k Ω \pm 1% resistor (0603) |
| R113, R115, R116, R119, R122, R123 | 6 | 10k Ω \pm 1% resistors (0603) |
| R117 | 1 | 1M Ω \pm 5% resistor (0603) |
| R118 | 1 | 34k Ω \pm 1% resistor (0603) |
| R121 | 1 | 30k Ω \pm 1% resistor (0603) |
| R124 | 1 | 20k Ω \pm 1% resistor (0603) |
| R125, R126, R127 | 3 | 200 Ω \pm 5% resistors (0603) |
| R131, R140 | 2 | 680 Ω \pm 5% resistors (0603) |
| R134, R136, R144, R145 | 4 | 10 Ω \pm 5% resistors (0603) |
| R135, R137, R138, R139, R141, R149, R150, R153 | 8 | 4.7k Ω \pm 5% resistors (0603) |
| R142 | 1 | 56 Ω \pm 5% resistor (0603) |
| R143 | 1 | 150 Ω \pm 5% resistor (0603) |
| R146, R147, R148, R152 | 4 | 100 Ω \pm 5% resistors (0603) |
| R155, R156, R158 | 3 | 180 Ω \pm 5% resistors (0603) |
| R159 | 1 | 47k Ω \pm 5% resistor (0603) |
| S100 | 1 | 4-position DIP switch |
| T1 | 1 | 198 μ H, 1:1:2.6:2.6, 400kHz transformer (8 Gull Wing) HALO Electronics TGM-H281NF |

MAX1300A Evaluation Kit

Evaluates: MAX1300A/MAX1300B

Component List (continued)

| DESIGNATION | QTY | DESCRIPTION |
|-------------------------|-----|---|
| TP1, TP3, TP5, TP101 | 4 | Red multipurpose test points |
| TP2, TP4, TP6, TP100 | 4 | Black multipurpose test points |
| U1 | 1 | 16-bit ADC (24 TSSOP) Maxim MAX1300AEUG+ |
| U2, U3 | 0 | Not installed, input buffers (8 SO) Maxim MAX9632ASA+ |
| U4 | 1 | 4.096V reference (8 SO) Maxim MAX6126AASA41+ |
| U5, U6, U7 | 3 | High-speed optocouplers (8 DIP) Vishay VO2631 |
| U8, U9 | 2 | 5V linear regulators (8 SO) Maxim MAX1659ESA+ |
| U10 | 1 | H-bridge driver (8 SO-EP) Maxim MAX256ASA+ |
| U100 | 1 | Low-power microcontroller (68 QFN-EP) Maxim MAXQ2000-RAX+ |
| U101 | 1 | USB-to-UART converter (32 TQFP) |
| U102 | 1 | 93C46A 3-wire EEPROM (8 SO) |

| DESIGNATION | QTY | DESCRIPTION |
|---------------------|-----|--|
| U103, U104, U106 | 3 | LDOs (16 TSSOP-EP) Maxim MAX1793EUE33+ |
| U105 | 1 | Step-up regulator (8 μ MAX [®]) Maxim MAX1795EUA+ |
| U107 | 1 | LDO (6 SOT23) Maxim MAX1983EUT+ |
| U108 | 1 | SRAM (48 TSOP) |
| U109 | 0 | Not installed, flash PROM (20 VO) |
| U110 | 1 | Atmel SPI [™] flash (8 SO) |
| U111 | 1 | Spartan 3A FPGA (144-TQFP) Xilinx XC3S50A-4TQG144I |
| Y100 | 1 | 16MHz crystal Hong Kong X'tals SSM16000N1HK188F0-0 |
| Y101 | 0 | Not installed, 32.768kHz crystal |
| Y102 | 1 | 6MHz crystal Hong Kong X'tals SSL60000N1HK188F0-0 |
| Y103 | 1 | 50MHz oscillator |
| — | 1 | USB high-speed A-to-B cables, 5ft (1.5m) |
| — | 16 | Shunts |
| — | 1 | PCB: MAX1300A EVALUATION KIT |

Component Suppliers

| SUPPLIER | PHONE | WEBSITE |
|----------------------------------|---------------|-----------------------------|
| Coilcraft, Inc. | 847-639-6400 | www.coilcraft.com |
| Diodes Incorporated | 805-446-4800 | www.diodes.com |
| Fairchild Semiconductor | 888-522-5372 | www.fairchildsemi.com |
| HALO Electronics, Inc. | 650-903-3800 | www.haloelectronics.com |
| Hong Kong X'tals Ltd. | +852-35112388 | www.hongkongcrystal.com |
| Murata Electronics North America | 770-436-1300 | www.murata-northamerica.com |
| Panasonic Corp. | 800-344-2112 | www.panasonic.com |
| SANYO Electric Co., Ltd. | 619-661-6835 | www.sanyo.com |
| TDK Corp. | 847-803-6100 | www.component.tdk.com |
| Vishay | 402-563-6866 | www.vishay.com |

Note: Indicate that you are using the MAX1300A when contacting these component suppliers.

μ MAX is a registered trademark of Maxim Integrated Products, Inc.

SPI is a trademark of Motorola, Inc.

MAX1300A Evaluation Kit

Evaluates: MAX1300A/MAX1300B

MAX1300A EV Kit Files

| FILE | DESCRIPTION |
|-------------------------|--|
| INSTALL.EXE | Installs the EV kit files on your computer |
| MAX1300A.EXE | Application program |
| CDM20600.EXE | Installs the USB device driver |
| UNINSTALL.EXE | Uninstalls the EV kit software |
| USB_Driver_Help_200.PDF | USB driver installation help file |

Quick Start

Recommended Equipment

- MAX1300A EV kit (USB cable included)
- Windows XP, Windows Vista, or Windows 7 PC with a spare USB port
- Signal generator
- +5V (500mA) power supply

Note: In the following sections, software-related items are identified by bolding. Text in **bold** refers to items directly from the EV kit software. Text in **bold and underlined** refers to items from the Windows operating system.

Procedure

The EV kit is fully assembled and tested. Follow the steps below to verify board operation:

- 1) Visit www.maxim-ic.com/evkitsoftware to download the latest version of the EV kit software, 1300ARxx.ZIP. Save the EV kit software to a temporary folder and uncompress the ZIP file.
- 2) Install the EV kit software and USB driver on your computer by running the INSTALL.EXE program inside the temporary folder. The program files are copied to your PC and icons are created in the Windows **Start | Programs** menu. During software installation, some versions of Windows may show a warning message indicating that this software is from an unknown publisher. This is not an error condition and it is safe to proceed with installation. Administrator privileges are required to install the USB device driver on Windows.
- 3) Verify that all jumpers are in their default positions, as shown in Tables 1 and 2.
- 4) Connect the USB cable from the PC to the EV kit board. A Windows message appears when connecting the EV kit board to the PC for the first time. Each version of Windows has a slightly different message. If you see a Windows message stating

ready to use, then proceed to the next step. Otherwise, open the USB_Driver_Help_200.PDF document in the Windows **Start | Programs** menu to verify that the USB driver was installed successfully.

- 5) Connect the positive terminal of the +5V power supply to the VIN banana jack and the GND terminal to the PGND banana jack.
- 6) Set the signal generator to output a 1kHz sine wave with an amplitude of 1V_{p-p}.
- 7) Connect the negative terminal of the signal generator to the AGND PCB pad and the positive terminal of the signal generator to the AIN0 PCB pad.
- 8) Start the EV kit software by opening its icon in the **Start | Programs** menu. The EV kit software main window appears, as shown in Figure 1. The GUI indicates whether the USB hardware is connected in the lower-left status bar.
- 9) Press the **Start Conversion** button in the **Data Logging** group box.
- 10) Verify that a 1kHz sine wave with an amplitude of 1V_{p-p} is displayed. The FFT and histogram of the signal can be viewed by clicking on the **Frequency Domain** and **Histogram** tab sheets.

Detailed Description of Software

The MAX1300A EV kit software main window is shown in Figure 1. The main window of the GUI contains a **Device Configuration** group box, a **Data Logging** group box, and four tab sheets to display the sampled data. The EV kit software allows various sample sizes and sample rates for use with the **Scope** plot in the **Time Domain** tab sheet. The **FFT** spectral energy is displayed in the **Frequency Domain** tab sheet. The **Histogram** tab sheet displays the distribution of the sampled ADC codes. The **Single Conversion** tab sheet displays the ADC codes and the corresponding voltage values of one data sample for all ADC input channels.

MAX1300A Evaluation Kit

Evaluates: MAX1300A/MAX1300B

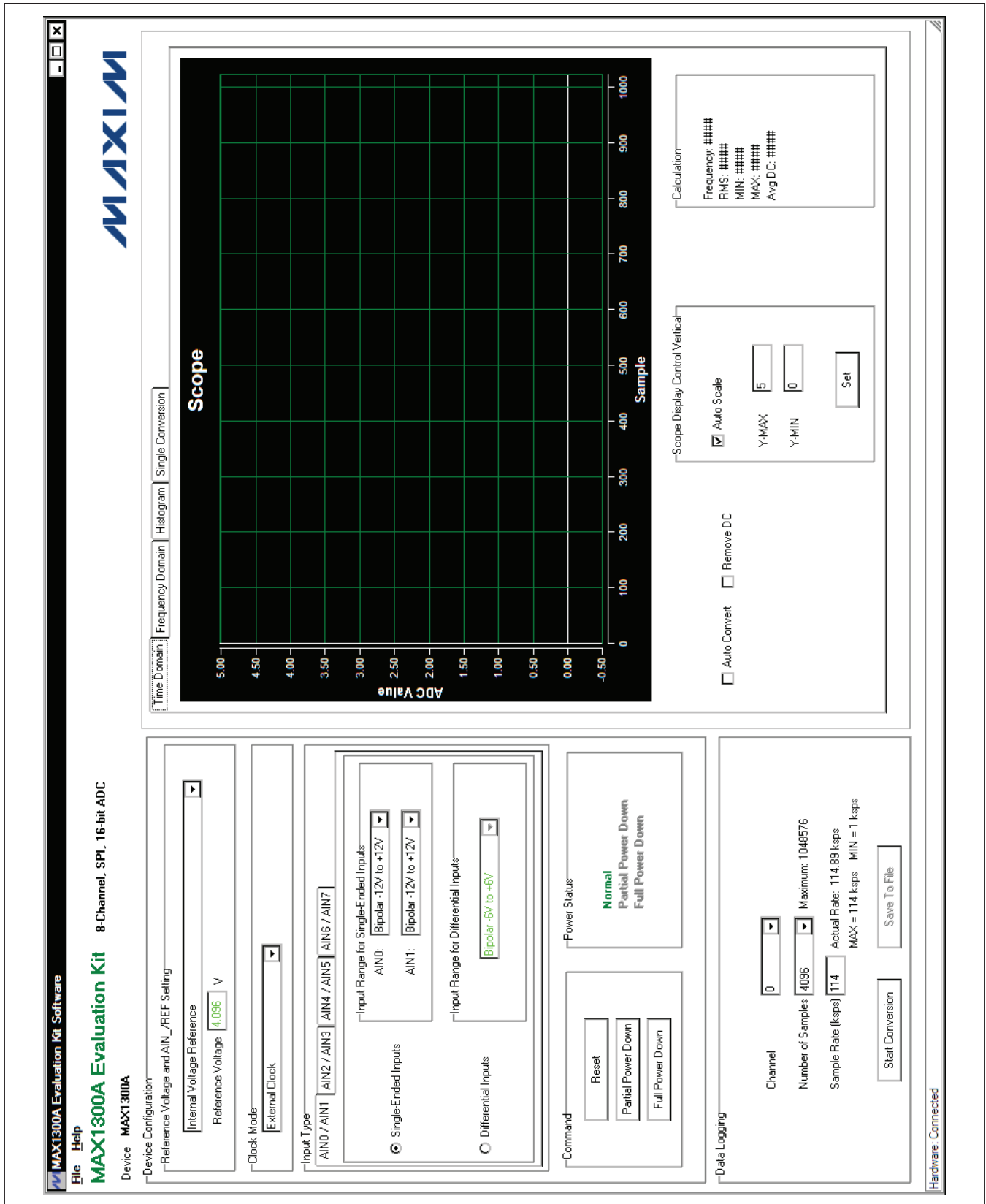

Figure 1. MAX1300A EV Kit Software (Main Window)

MAX1300A Evaluation Kit

Evaluates: MAX1300A/MAX1300B

Device Configuration

The **Device Configuration** group box is used to configure the IC. The configurable settings are: reference voltage, clock, analog input settings, and power-down state.

The **Reference Voltage and AIN_/REF Setting** group box selects between the internal reference, on-board reference (default), and user-applied reference. If the source of the voltage reference is set to an external reference, enter the precise voltage value in the **Reference Voltage** edit box. This value is used to calculate the voltage from the ADC code.

The **Clock Mode** group box selects one of the three different conversion methods (**External Clock**, **External Acquisition**, or **Internal Clock**). The **External Clock** mode is the default. This mode allows the fastest throughput. The SCLK is used as the external clock; no external clock needs to be provided. Selecting between the different modes affects the sample rate.

The **Input Type** group box selects the settings for the ADC inputs. The input channels are configurable for single-ended or differential inputs in unipolar or bipolar mode. The four tabs select the settings for the four pair of analog inputs that can be driven differentially. For maximum accuracy, select the minimum input range that covers the sampled signal.

In the **Command** group box, press the **Reset** button to reset the ADC to its default condition. Press the **Partial Power Down** button to place the ADC into partial power-down mode. Press the **Full Power Down** button to place the ADC into full power-down mode. The **Power Status** group box displays the power state of the ADC device.

Data Logging

In the **Data Logging** group box, the user can select the **Channel** and the desired number of conversions from the **Number of Samples** drop-down list. Enter the desired sampling rate in the **Sample Rate (ksps)** edit box. The actual sampling rate is displayed at the right of the **Sample Rate (ksps)** edit box. Press the **Start Conversion** button to start sampling. After sampling is finished, the user can save the data to a file by pressing the **Save To File** button. The **Save To File** button is not active until the sampling is done.

Time Domain/Frequency

Domain/Histogram/Single Conversion Tabs

After the **Start Conversion** button in the **Data Logging** group box is pressed, the sampled data in the time domain is plotted in the **Time Domain** tab sheet. The sampled data in the frequency domain is plotted in the **Frequency Domain** tab sheet. The histogram of the sampled signal is plotted in the **Histogram** tab sheet.

When the **Single Conversion** tab sheet is selected, press the **Start Conversion** button to read one sample data for all ADC input channels.

Check the **Auto Convert** checkbox to automatically and repeatedly do the ADC conversions and update the active tab sheet.

Time Domain Tab

In the **Time Domain** tab sheet (Figure 2), check the **Remove DC** checkbox to remove the DC component of the sampled signal. In the **Scope Display Control Vertical** group box, when the **Auto Scale** checkbox is checked, the software automatically scales the vertical axis in the plot. If the **Auto Scale** checkbox is unchecked, enter the appropriate values into the **Y-MAX** and **Y-MIN** edit boxes and press the **Set** button to set the boundaries for the vertical axis. The software automatically calculates the **Frequency**, **RMS**, **MIN**, **MAX**, and **Avg DC** of the sampled signal, and displays the calculated values in the **Calculation** group box.

Frequency Domain Tab

The **Frequency Domain** tab sheet (Figure 3) displays the FFT plot of the signal shown in the **Time Domain** tab sheet.

Histogram Tab

The **Histogram** tab sheet (Figure 4) displays the histogram of the signal shown in the **Time Domain** tab sheet. The software automatically calculates the **Mean** and the **Std Dev** (standard deviation, sigma), and displays the calculated values in the **Calculation** group box.

The **Histogram Display Control** radio group box provides three options to scale the horizontal axis on the histogram. The options are:

- 1) **(Mean - 3 sigma) to (Mean + 3 sigma)**
- 2) **(Mean - 6 sigma) to (Mean + 6 sigma)**
- 3) **User Define** range

Histograms can be taken for DC or AC signal sources. Figure 4 shows the histogram of a 5kHz sine-wave signal while Figure 5 shows the histogram of a 1V DC signal.

Single Conversion Tab

The **ADC Value Display for Single Conversion** group box in the **Single Conversion** tab sheet (Figure 6) displays the **ADC Code** and the calculated **Voltage** values for a single sample of all the ADC input channels. Pressing the **Start Conversion** button in the **Data Logging** group box updates the status of the **ADC Value Display for Single Conversion** group box.

MAX1300A Evaluation Kit

Evaluates: MAX1300A/MAX1300B

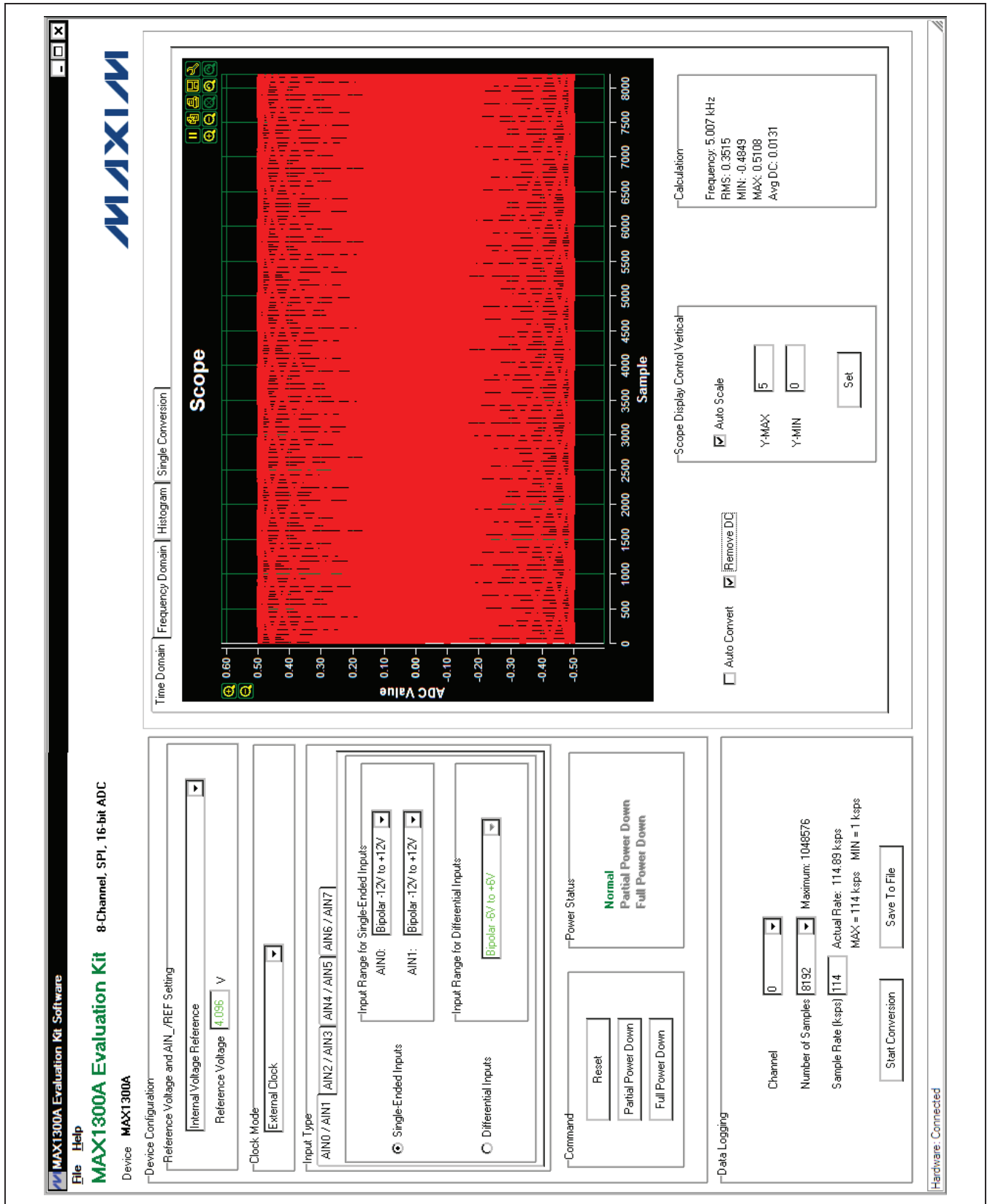

Figure 2. MAX1300A EV Kit Software (Time Domain Tab)

MAX1300A Evaluation Kit

Evaluates: MAX1300A/MAX1300B

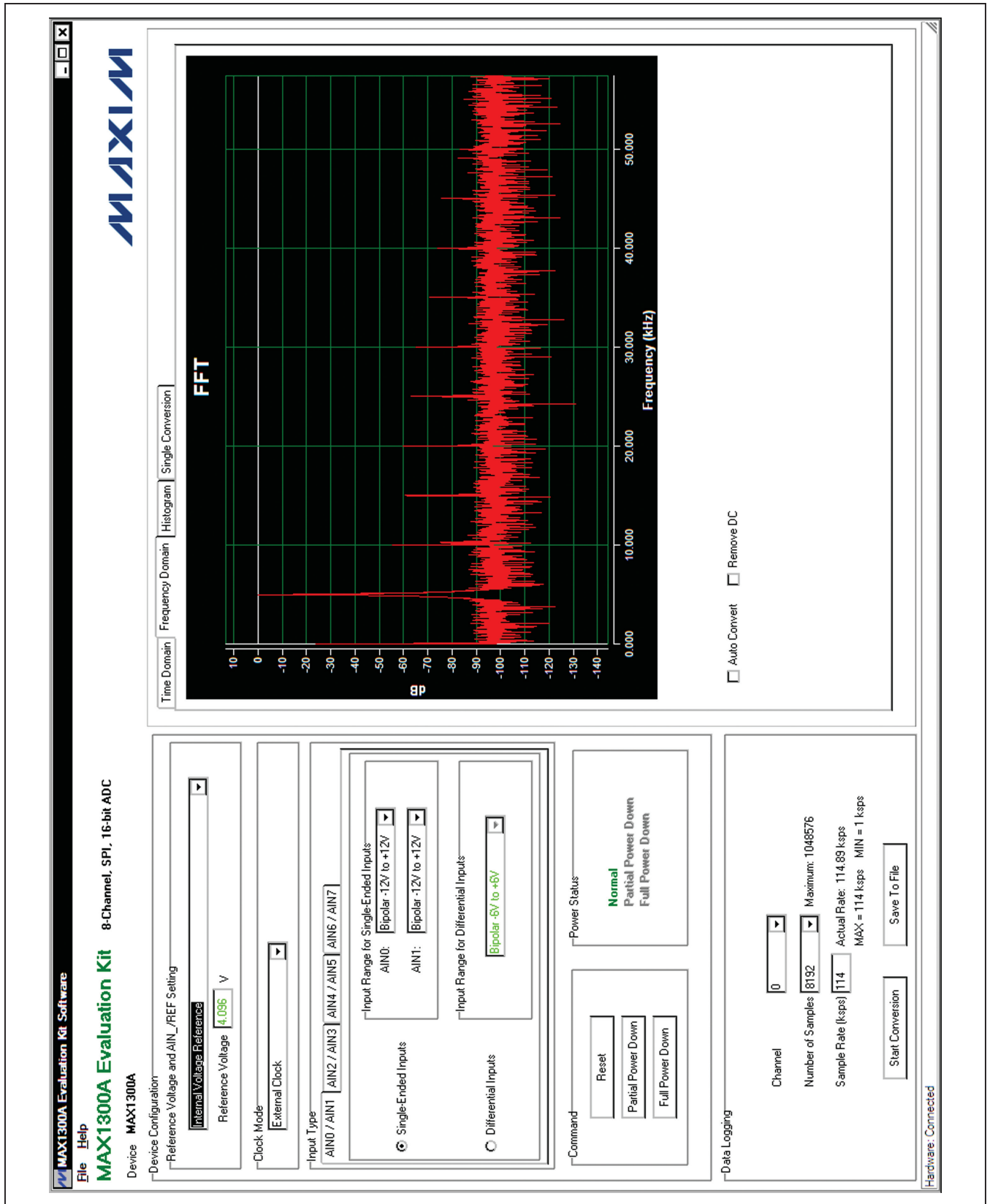

Figure 3. MAX1300A EV Kit Software (Frequency Domain Tab)

MAX1300A Evaluation Kit

Evaluates: MAX1300A/MAX1300B

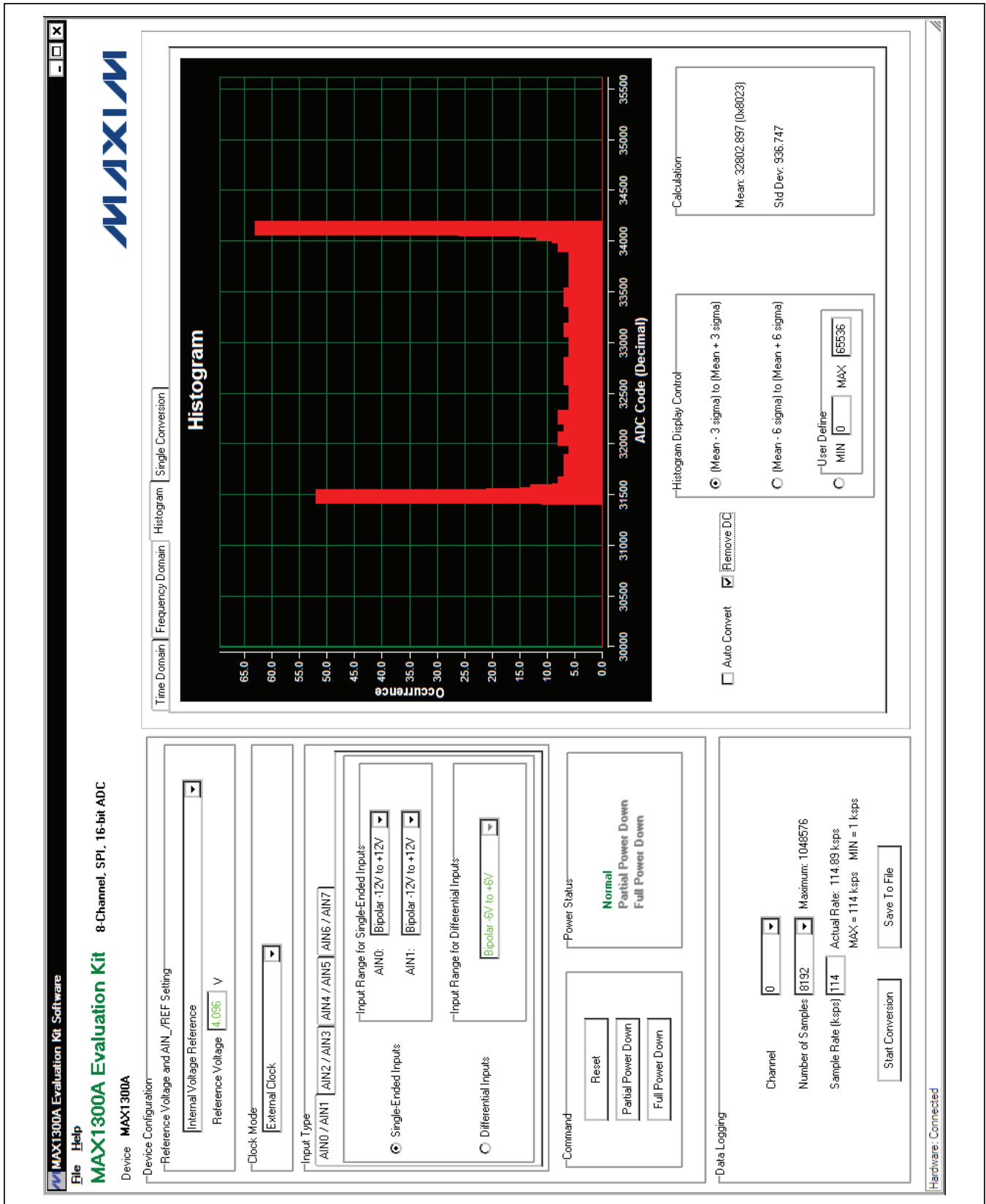

Figure 4. MAX1300A EV Kit Software (Histogram Tab—5kHz Sine-Wave Signal)

MAX1300A Evaluation Kit

Evaluates: MAX1300A/MAX1300B

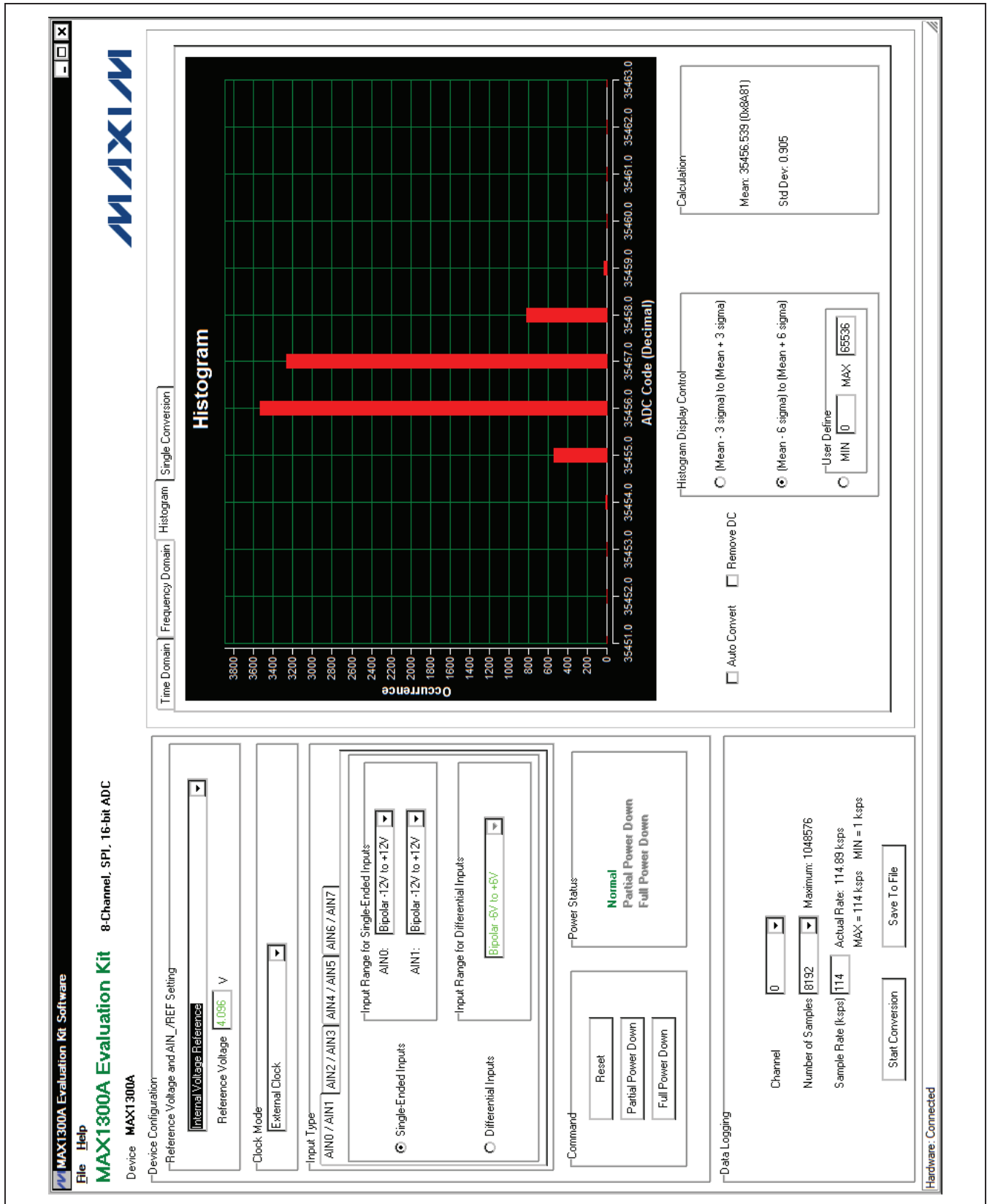

Figure 5. MAX1300A EV Kit Software (Histogram Tab—1V DC Signal)

MAX1300A Evaluation Kit

Evaluates: MAX1300A/MAX1300B

The screenshot displays the MAX1300A Evaluation Kit Software interface. At the top, the MAXIM logo is visible. The window title is "MAX1300A Evaluation Kit Software". Below the title bar, the text reads "8-Channel, SPI, 16-bit ADC" and "MAX1300A Evaluation Kit". The device is identified as "MAX1300A".

The interface is divided into several sections:

- Device Configuration:**
 - Reference Voltage and AIN_n/REF Setting: Internal Voltage Reference (dropdown), Reference Voltage: 4.096 V.
 - Clock Mode: External Clock (dropdown).
 - Input Type: AIN0 / AIN1, AIN2 / AIN3, AIN4 / AIN5, AIN6 / AIN7 (dropdown).
 - Input Range for Single-Ended Inputs: AIN0: Bipolar -12V to +12V (dropdown), AIN1: Bipolar -12V to +12V (dropdown).
 - Input Range for Differential Inputs: Bipolar -6V to +6V (dropdown).
 - Radio buttons for "Single-Ended Inputs" (selected) and "Differential Inputs".
- Command:**
 - Buttons: Reset, Partial Power Down, Full Power Down.
- Power Status:**
 - Normal (green text)
 - Partial Power Down
 - Full Power Down
- Data Logging:**
 - Channel: 0 (dropdown)
 - Number of Samples: 256 (dropdown), Maximum: 1048576
 - Sample Rate (ksps): 114 (dropdown), Actual Rate: 114.89 ksps, MAX = 114 ksps, MIN = 1 ksps
 - Buttons: Start Conversion, Save To File
- ADC Value Display for Single Conversion:**
 - Time Domain | Frequency Domain | Histogram | Single Conversion (selected)
 - Table of conversion results for Channels 0 through 7.
- Controls:**
 - Auto Convert: (unchecked)
 - Remove DC: (checked)

ADC Value Display for Single Conversion:

| Channel | Code | Voltage |
|-----------|--------|---------|
| Channel 0 | 0x7FEE | -0.0067 |
| Channel 1 | 0x99E5 | 2.4859 |
| Channel 2 | 0x99D2 | 2.4788 |
| Channel 3 | 0x99CE | 2.4773 |
| Channel 4 | 0x99CF | 2.4776 |
| Channel 5 | 0x99CD | 2.4769 |
| Channel 6 | 0x99CD | 2.4769 |
| Channel 7 | 0x99CE | 2.4773 |

Hardware: Connected

Figure 6. MAX1300A EV Kit Software (Single Conversion Tab)

MAX1300A Evaluation Kit

Evaluates: MAX1300A/MAX1300B

Table 1. Master-Side Jumper Settings (JU101–JU104)

| JUMPER | SHUNT POSITION | DESCRIPTION |
|--------|----------------|---|
| JU101 | Installed* | The on-board LDO (U103) provides 3.6V to the EV kit for internal use. |
| | Not installed | Disconnects the output of the on-board LDO (U103). |
| JU102 | Installed* | The on-board LDO (U104) provides 2.5V to the EV kit for internal use. |
| | Not installed | Disconnects the output of the on-board LDO (U104). |
| JU103 | 1-2* | The on-board LDO (U106) provides 5V to the EV kit for internal use. |
| | 2-3 | Disconnects the output of the on-board LDO (U106). |
| JU104 | Installed* | The on-board LDO (U107) provides 1.2V to the EV kit for internal use. |
| | Not installed | Disconnects the output of the on-board LDO (U106). |

*Default position.

Table 2. IC-Side Jumper Settings (JU1–JU12)

| JUMPER | SHUNT POSITION | DESCRIPTION |
|--------|----------------|---|
| JU1 | 1-2* | On-board SPI. Connects the \overline{CS} signal to the internal interface. |
| | 2-3 | User-supplied SPI. Apply the \overline{CS} signal to the \overline{CS} PCB pad. |
| JU2 | 1-2* | On-board SPI. Connects the DIN signal to the internal interface. |
| | 2-3 | User-supplied SPI. Apply the DIN signal to the DIN PCB pad. |
| JU3 | 1-2* | On-board SPI. Connects the SSTRB signal to the internal interface. |
| | 2-3 | User-supplied SPI. Apply the SSTRB signal to the SSTRB PCB pad. |
| JU4 | 1-2* | On-board SPI. Connects the SCLK signal to the internal interface. |
| | 2-3 | User-supplied SPI. Apply the SCLK signal to the SCLK PCB pad. |
| JU5 | 1-2* | On-board SPI. Connects the DOUT signal to the internal interface. |
| | 2-3 | User-supplied SPI. Apply the DOUT signal to the DOUT PCB pad. |
| JU6 | 1-2 | AIN0 uses the input buffer (U2). |
| | 2-3* | AIN0 bypasses the input buffer. |
| JU7 | 1-2 | AIN1 uses the input buffer (U3). |
| | 2-3* | AIN1 bypasses the input buffer. |
| JU8 | 1-2* | Connects the on-board external reference (U4) to the ADC reference input of U1. |
| | 2-3 | Connects the ADC reference input pin to the VREF PCB pad. |
| JU9 | Installed* | Uses the external ADC reference. |
| | Not installed | Uses the internal ADC reference. |
| JU10 | 1-2* | DVDD powered by the on-board supply. |
| | 2-3 | DVDD powered by the user-supplied voltage on the EXT_DVDD test point. |
| JU11 | 1-2* | AVDD powered by the on-board supply. |
| | 2-3 | AVDD powered by the user-supplied voltage on the EXT_AVDD test point. |
| JU12 | 1-2* | DVDDO powered by the on-board supply. |
| | 2-3 | DVDDO powered by the user-supplied voltage on the EXT_DVDDO test point. Change this setting only for user-supplied SPI. |

*Default position.

MAX1300A Evaluation Kit

Evaluates: MAX1300A/MAX1300B

Detailed Description of Hardware

The MAX1300A EV kit board provides a proven layout for evaluating the MAX1300A. The EV kit comes with a MAX1300AEUG+ installed. The EV kit isolates the control-side circuit from the IC circuitry to reduce the noise level in order to evaluate the IC over its full dynamic range.

Control Side

The EV kit has an on-board Xilinx FPGA for testing the IC's maximum throughput (115ksps) and acquiring mega-sample sizes (1Ms) for detailed precision.

Input Power

The EV kit is powered through the VIN and PGND banana jacks. Apply +5V (500mA) on the VIN banana jack. The VIN input supplies power to the whole board, including the IC circuitry.

Isolated Power Supply

The EV kit requires both analog and digital power supplies. An on-board transformer and two LDOs generate the analog and digital power supplies.

There are two digital supplies (DVDD and DVDDO). DVDD and DVDDO are set to +5V by default. DVDDO is set to +5V because optocouplers are driving the interface signals coming from the control side. To apply a user-supplied DVDDO voltage, place a shunt across pins 2-3 of jumper JU12, as shown in Table 2, and apply the DVDDO voltage on the EXT_DVDDO test point. Only change the DVDDO supply for user-supplied SPI. To apply a user-supplied DVDD voltage, place a shunt across pins 2-3 of jumper JU10, as shown in Table 2, and apply the DVDD voltage on the EXT_DVDD test point.

The analog supply (AVDD) is set to +5V by default, and powers the IC and the on-board reference. AVDD is separated from DVDD in the layout to reduce cross-

coupling. To apply a user-supplied AVDD voltage, place a shunt across pins 2-3 on jumper JU11, as shown in Table 2, and apply the AVDD voltage on the EXT_AVDD test point.

If the user wants to use the input buffers for analog inputs AIN0 and AIN1, the U2 and U3 (MAX9632) buffers need to be installed and powered. Apply a +15V supply on the +15V PCB pad. Apply a -15V supply on the -15V PCB pad. Apply the grounds to the AGND PCB pads.

Voltage Reference

An on-board +4.096V voltage reference (U4) is provided on the EV kit. To use a user-supplied reference voltage, change the shunt on jumper JU8 to the 2-3 position and apply the reference voltage to the VREF PCB pad. Connect the negative terminal of the reference voltage to the AGND PCB pad nearest the VREF pad. By default, JU8 is in the 1-2 position for the on-board reference.

Isolated Interface (SPI)

The interface from the control side requires SPI plus the strobe signal. On the IC side, the interface signals are referenced to +5V from the default DVDDO supply.

User-Supplied Interface (SPI)

To use the EV kit with a user-supplied SPI, place a shunt across pins 2-3 on jumpers JU1–JU5. Connect the SSTRB, \overline{CS} , SCLK, DOUT, DIN, and DGND lines from the user-supplied SPI interface to the corresponding PCB pads on the EV kit. The user-supplied SPI interface is referenced to +5V by default. If the user-supplied master requires a lower voltage, apply an external voltage to the DVDDO supply.

The SSTRB signal is used to indicate to the digital interface that data is ready to be read from the IC. The SSTRB signal is used for internal clock mode. If additional pins are not available or standard SPI is required, do not use the internal clock mode.

MAX1300A Evaluation Kit

Evaluates: MAX1300A/MAX1300B

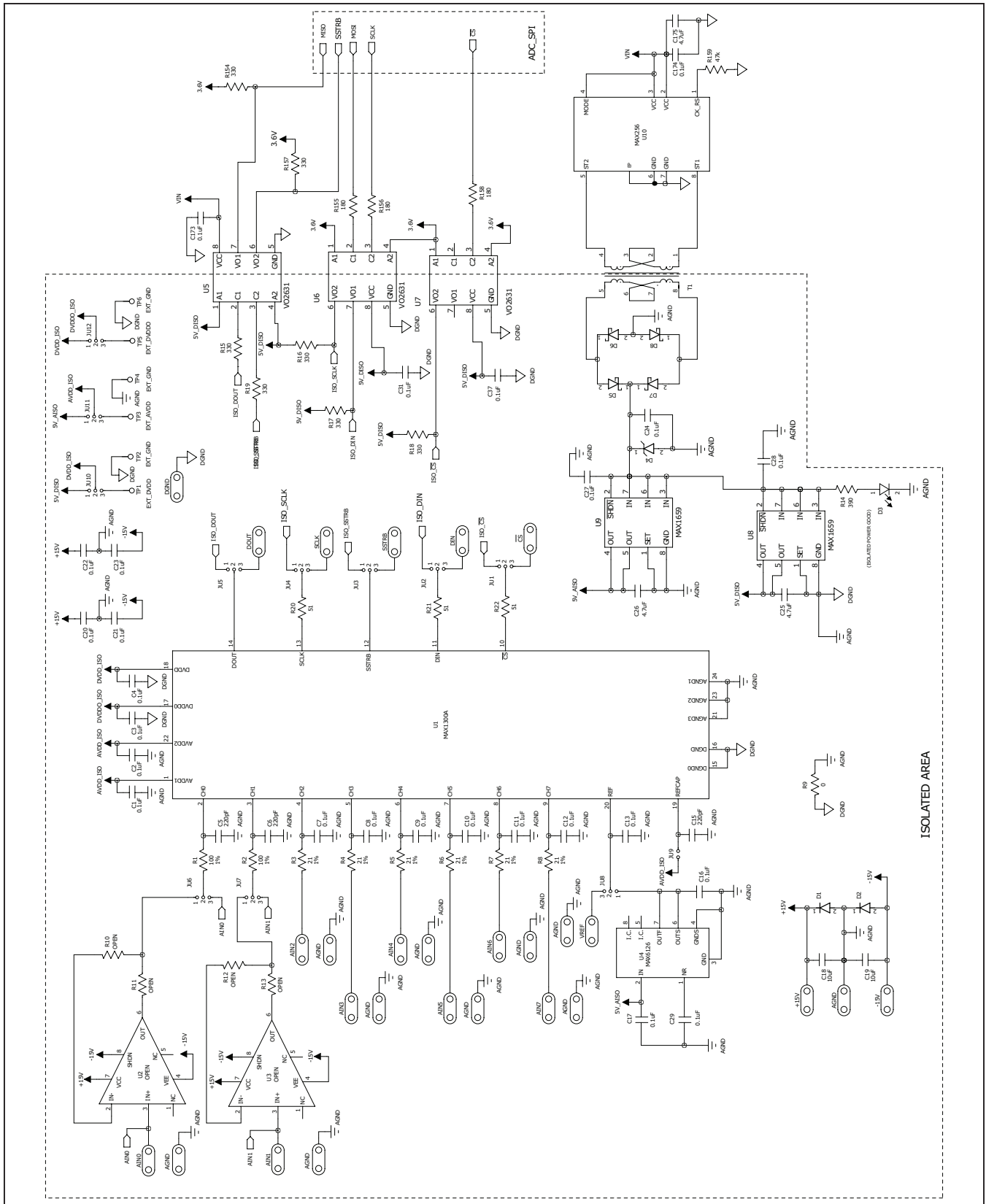

Figure 7a. MAX1300A EV Kit Schematic (Sheet 1 of 5)

MAX1300A Evaluation Kit

Evaluates: MAX1300A/MAX1300B

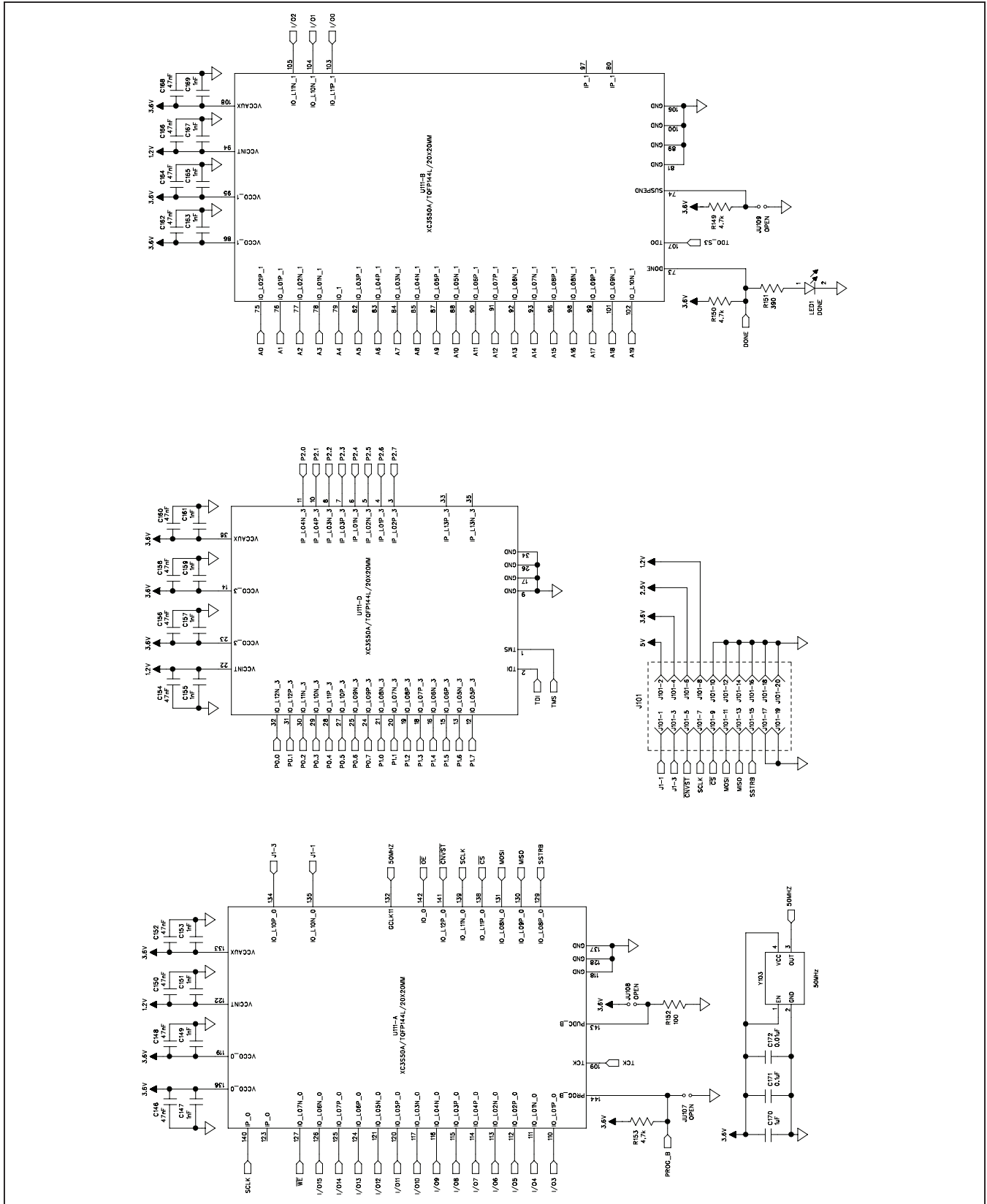

Figure 7b. MAX1300A EV Kit Schematic (Sheet 2 of 5)

MAX1300A Evaluation Kit

Evaluates: MAX1300A/MAX1300B

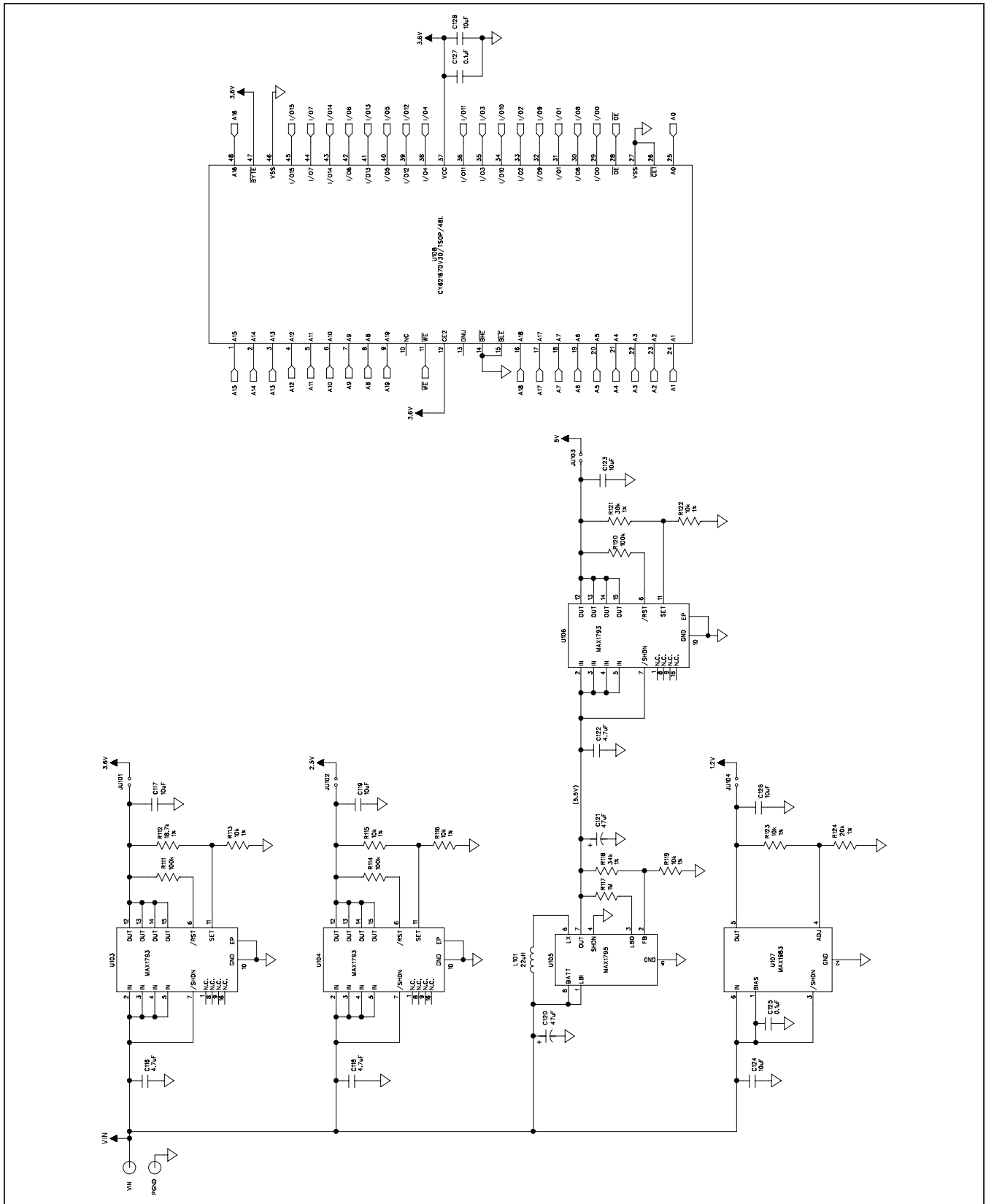

Figure 7d. MAX1300A EV Kit Schematic (Sheet 4 of 5)

MAX1300A Evaluation Kit

Evaluates: MAX1300A/MAX1300B

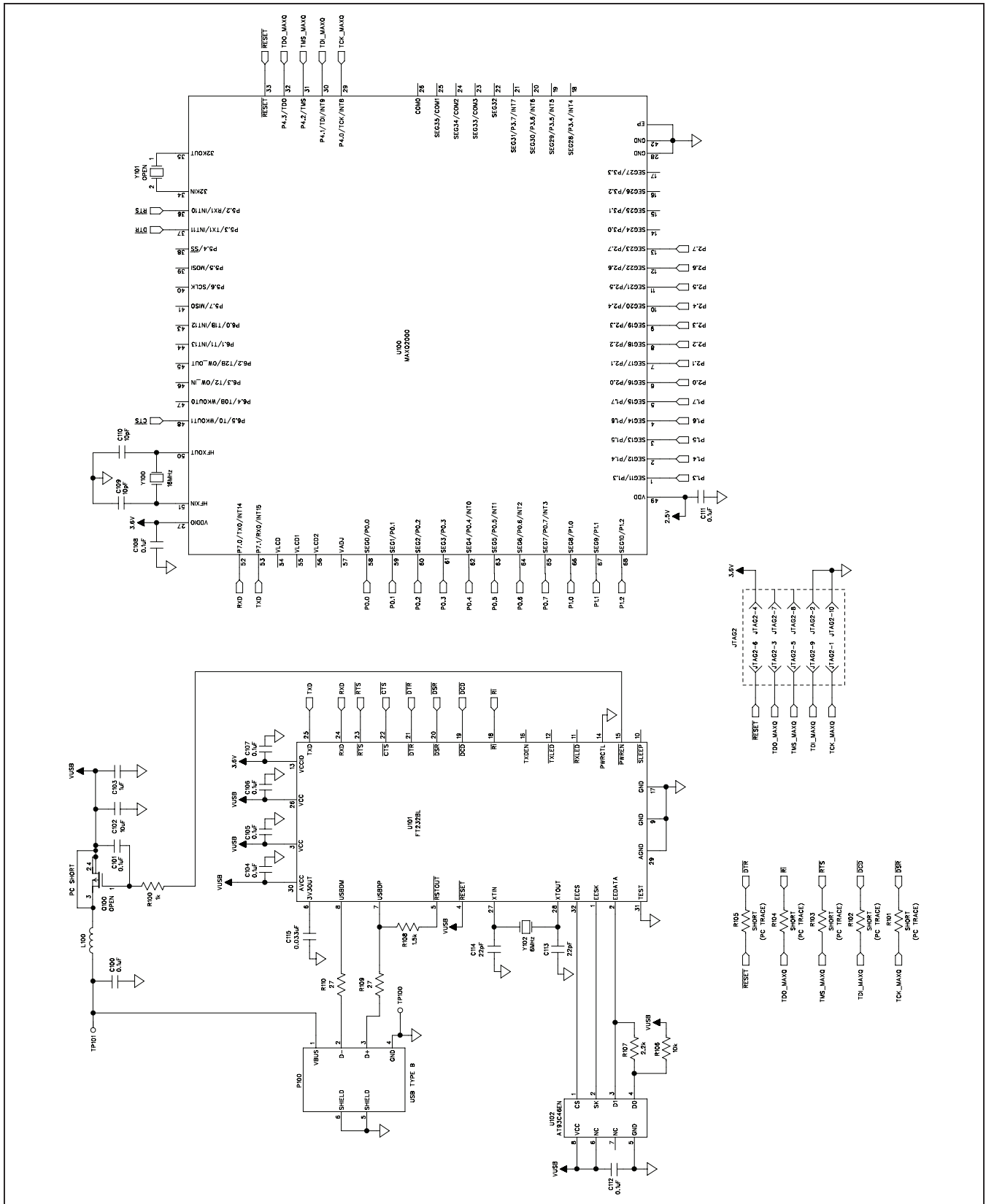

Figure 7e. MAX1300A EV Kit Schematic (Sheet 5 of 5)

MAX1300A Evaluation Kit

Evaluates: MAX1300A/MAX1300B

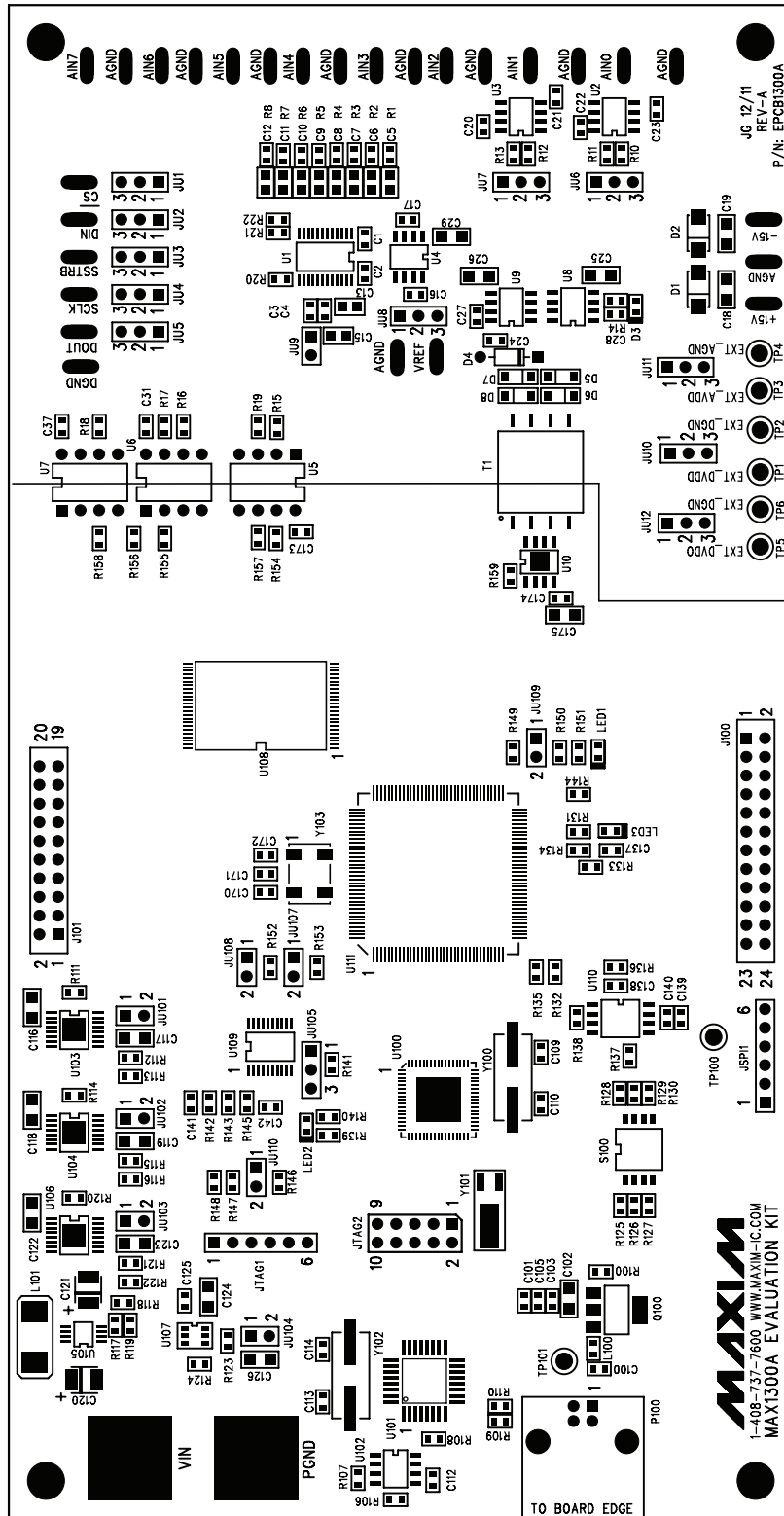

Figure 8. MAX1300A EV Kit Component Placement Guide—Component Side

MAX1300A Evaluation Kit

Evaluates: MAX1300A/MAX1300B

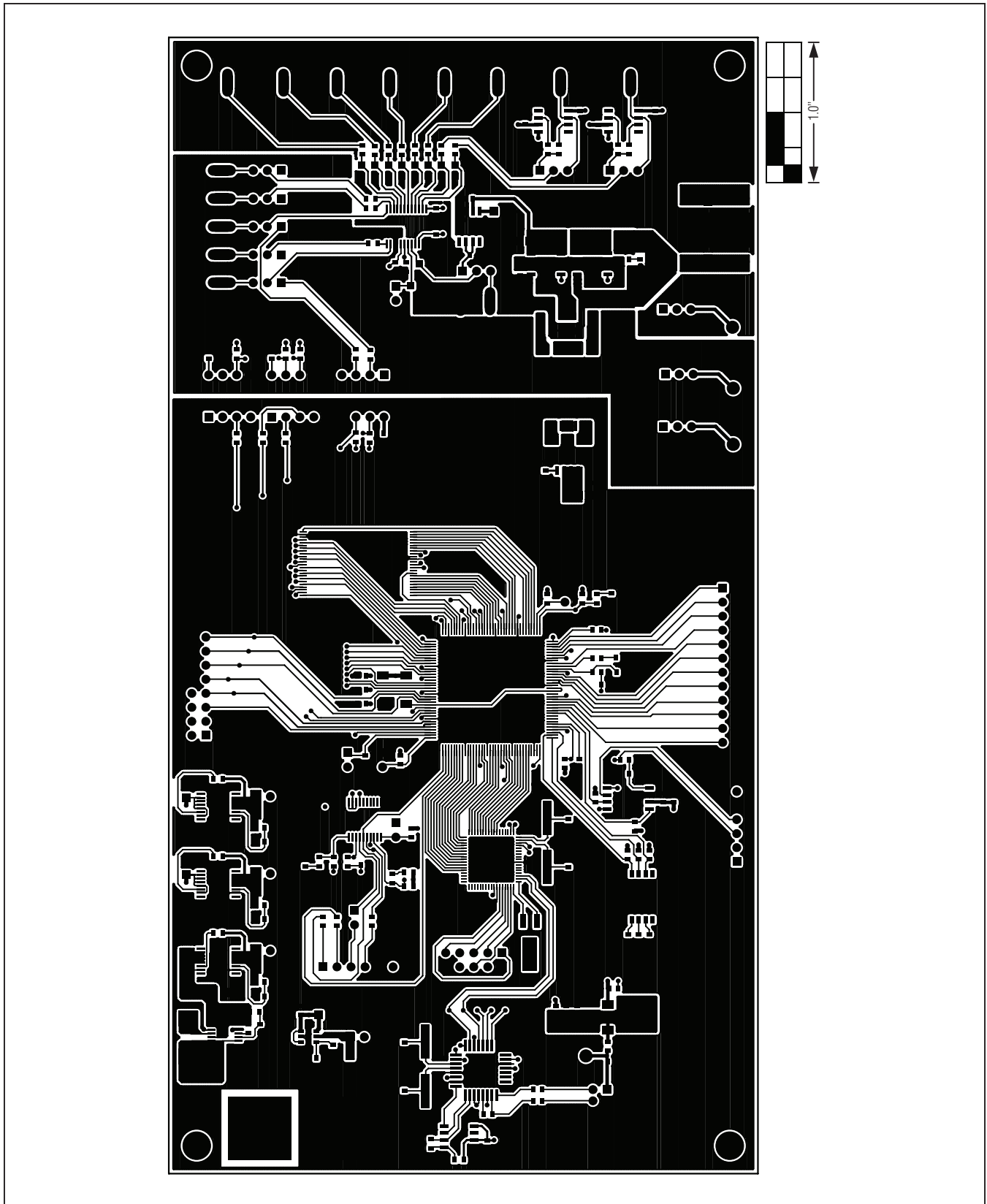

Figure 9. MAX1300A EV Kit PCB Layout—Component Side

MAX1300A Evaluation Kit

Evaluates: MAX1300A/MAX1300B

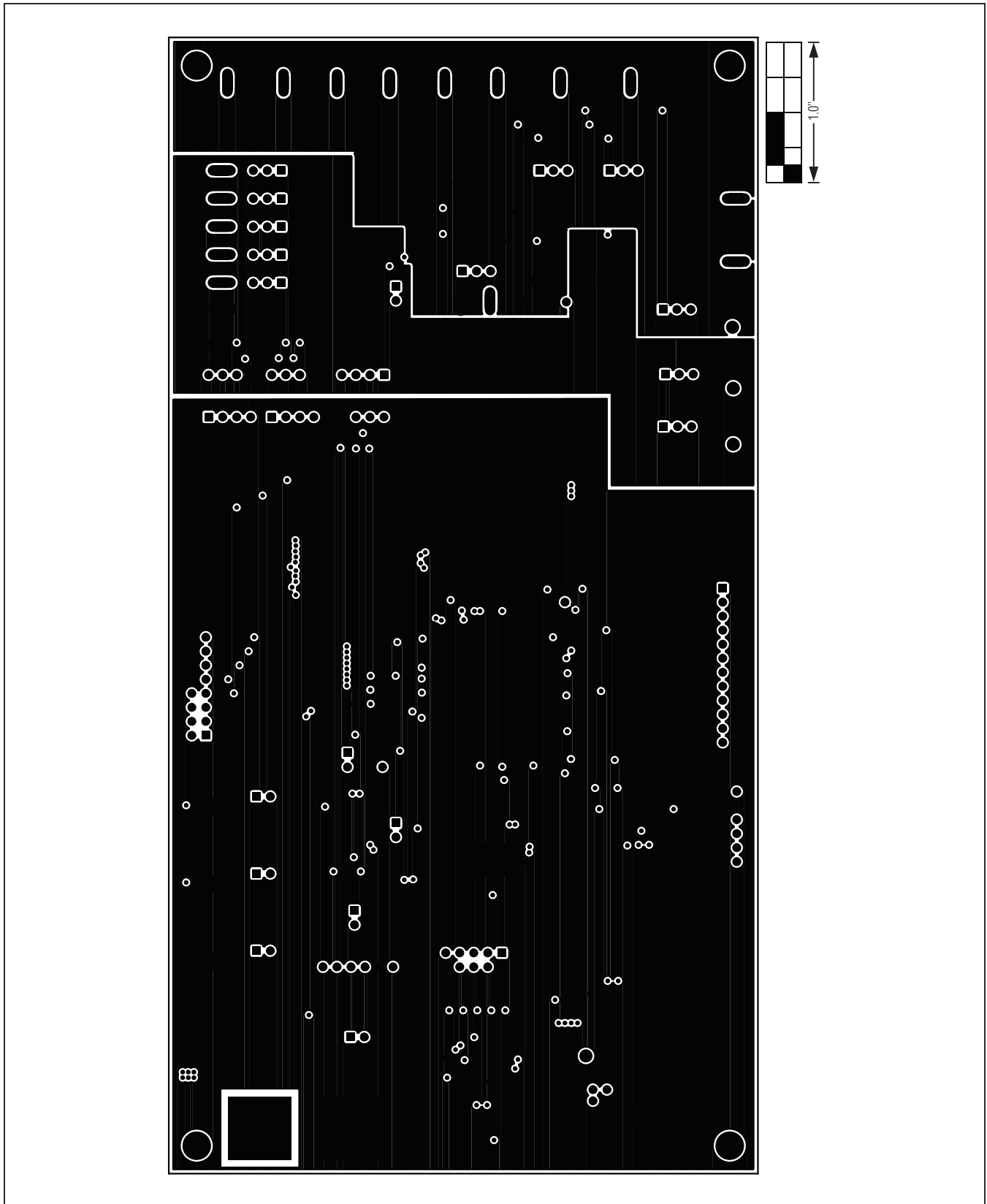

Figure 10. MAX1300A EV Kit PCB Layout—Layer 2

MAX1300A Evaluation Kit

Evaluates: MAX1300A/MAX1300B

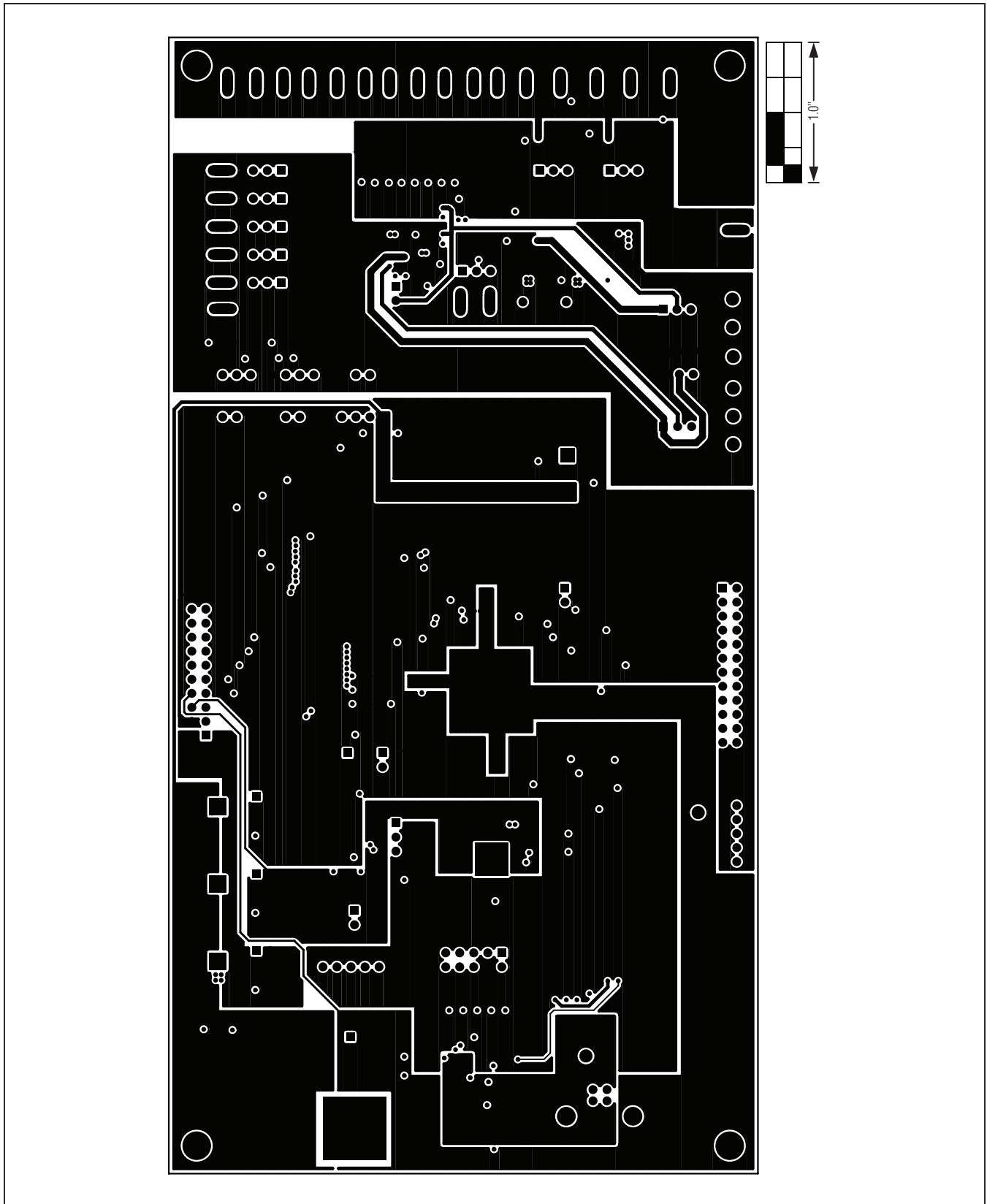

Figure 11. MAX1300A EV Kit PCB Layout—Layer 3

MAX1300A Evaluation Kit

Evaluates: MAX1300A/MAX1300B

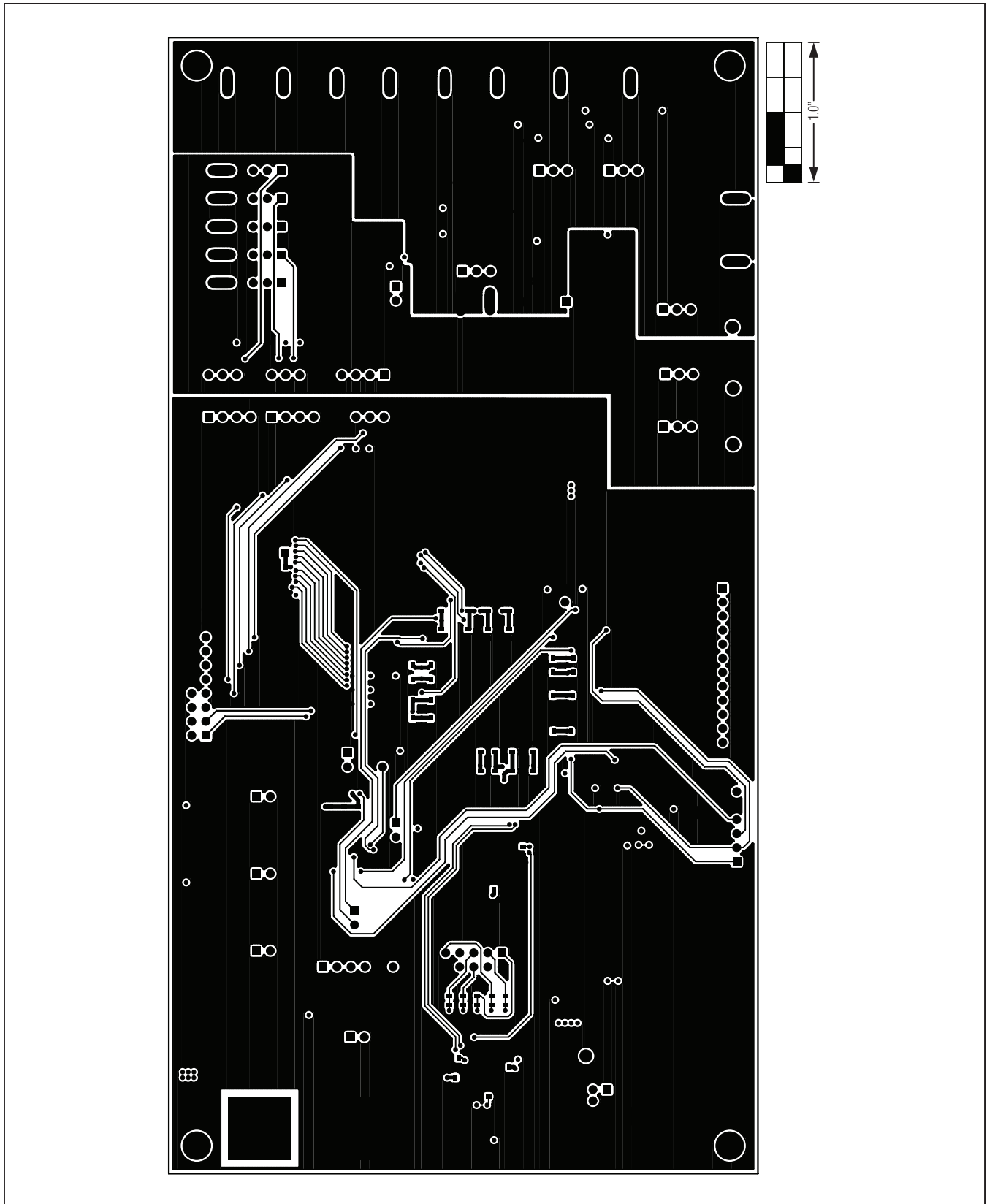

Figure 12. MAX1300A EV Kit PCB Layout—Solder Side

MAX1300A Evaluation Kit

Evaluates: MAX1300A/MAX1300B

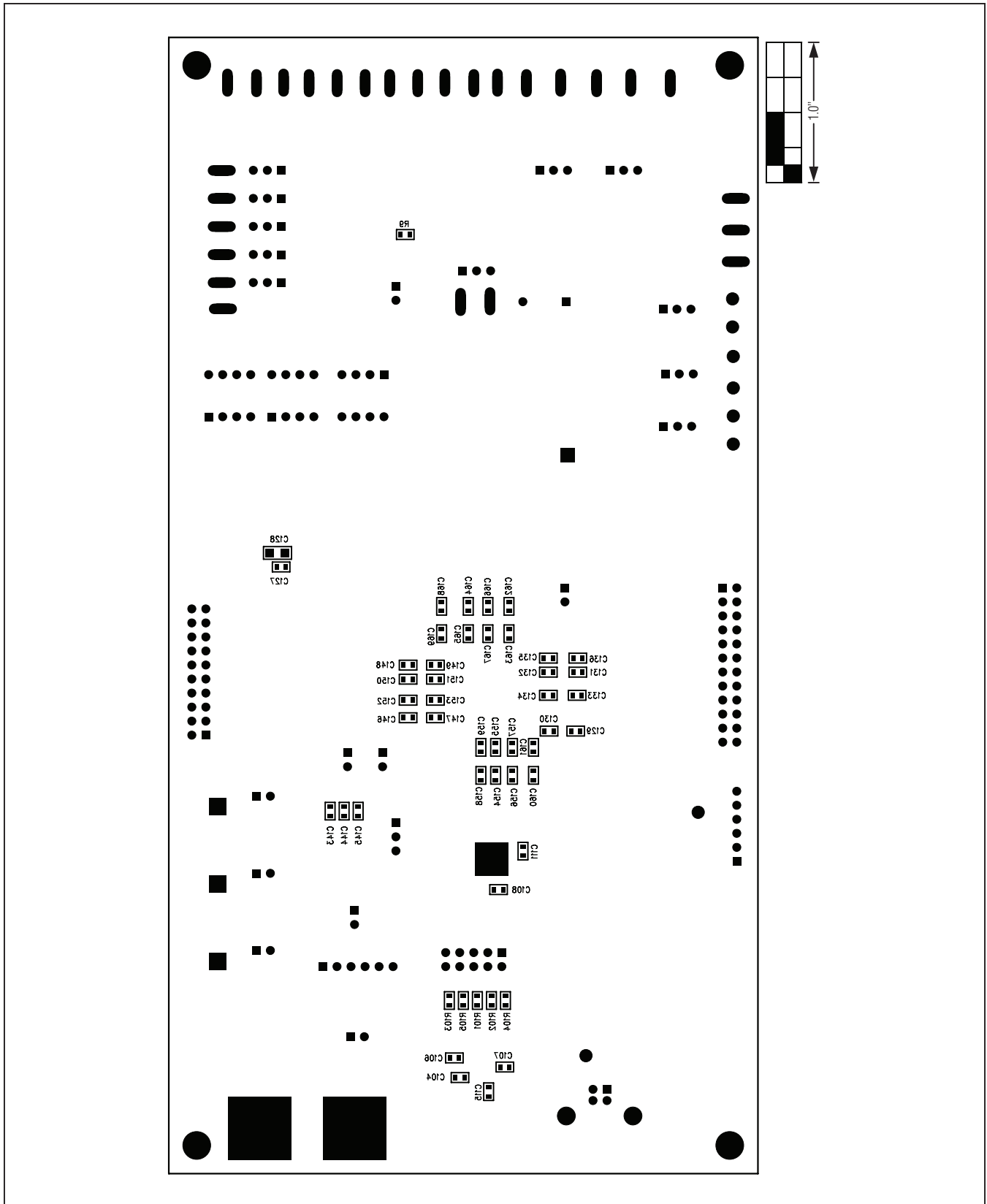

Figure 13. MAX1300A EV Kit Component Placement Guide—Solder Side

MAX1300A Evaluation Kit

Evaluates: MAX1300A/MAX1300B

Ordering Information

| PART | TYPE |
|----------------|-------------|
| MAX1300AEVKIT# | EV Kit |

#Denotes RoHS compliant

MAX1300A Evaluation Kit

Evaluates: MAX1300A/MAX1300B

Revision History

| REVISION NUMBER | REVISION DATE | DESCRIPTION | PAGES CHANGED |
|-----------------|---------------|-----------------|---------------|
| 0 | 2/12 | Initial release | — |

Maxim cannot assume responsibility for use of any circuitry other than circuitry entirely embodied in a Maxim product. No circuit patent licenses are implied. Maxim reserves the right to change the circuitry and specifications without notice at any time.

Maxim Integrated Products, 120 San Gabriel Drive, Sunnyvale, CA 94086 408-737-7600 _____ 26